

CATALOGO

www.carwashshop.it

CAR WASH
SHOP & SERVICE



COMPONENTI - ACCESSORI - ATTREZZATURE - RICAMBI per AUTOLAVAGGI

Numero Verde Gratuito

800 / 125790

MISSION

La mission aziendale è far fronte ad ogni necessità del cliente. La consulenza viene offerta tempestivamente, con la migliore e più completa soluzione possibile. Noi siamo il centro d'acquisto al servizio di ogni gestore, manutentore o rivenditore operante nell'ambito del lavaggio auto. Facciamo di onestà, chiarezza e disponibilità, secondo etica professionale, il nostro punto di forza.

CONTATTI:

e-mail: info@carwashshop.it
 Tel. +39 011 197 00 938
 +39 011 197 00 939
 Tel/fax: +39 011 66 96 125

DIRETTI:

COMMERCIALE (+39) 335 76 27 958
 MAGAZZINO (+39) 335 76 27 957

 car.wash.shop.service

I NOSTRI SERVIZI

Preventivi gratuiti
 Ricerca e reperimento componenti
 Imballo gratuito
 No minimi quantitativi d'ordine
 Spedizione con servizio espresso



ricerca: [carwashshop.ricambieaccessori](https://www.facebook.com/carwashshop.ricambieaccessori)

LOCALE TECNICO

POMPE AD ALTA PRESSIONE
 TRATTAMENTO ACQUA
 VALVOLE - ELETTROVALVOLE
 POMPE DOSATRICI

INDICE

3
 8
 10
 12

EQUIPAGGIAMENTO PISTE

BRACCI E RACCORDI
 TUBI E PISTOLE
 LANCE E SPAZZOLE

15
 17
 18

SISTEMI DI PAGAMENTO

GETTONIERE SCHEDE E PULSANTI
 EROGATORI STARTER E ACCESSORI

21
 22

ACCESSORI

MACCHINARI E ACCESSORI
 ATTREZZATURE E PRODOTTI DI CONSUMO

23
 29

ESPLOSO POMPA CAT

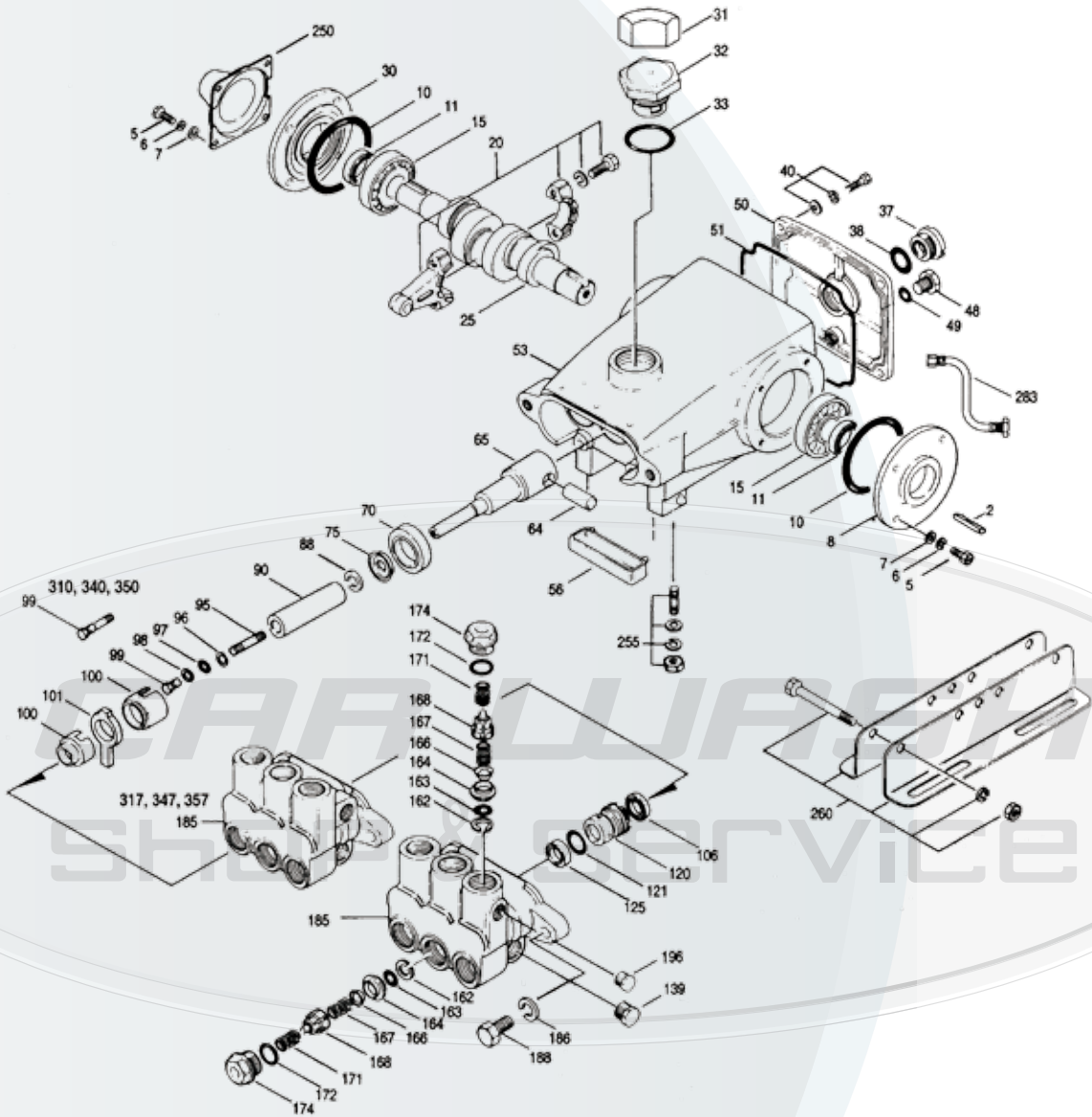

Compressore pompa 350

Compressore pompa 3cp 1140



Testata pompa CAT
(185) 310/340/350

T 701010

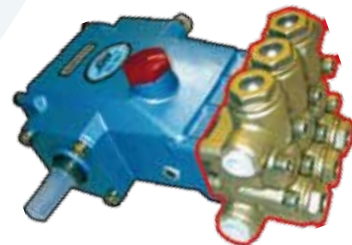

Testata pompa
3cp - 1140

T701010-3cp

Kit 3 valvole
350/340/310/5CP 2150



T703010

Kit guarnizioni di tenuta
350/340/310



T703020

Campana di accoppia-
mento 310/340/350



T703030

Giunto flessibile
350/340/310/5CP 2150



T703060

Guarnizione nera valvola
Guarnizione teflon valvola



T703280

T703350

Canotto sede pistone



T703120

Protezione albero 350



T703040

Olio Fuchs (5Lt) per pompa
CAT



FUCHS1

Guarnizione labbro
cuscinetto 350/5CP



Guarnizione
corteco pistone
carter 310/340/350



Guarnizione tappo
valvola 350/5CP



O-ring cuscinetto 350



Guarnizione posteriore
350

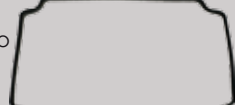

T703170

T703250

T703230

T703210

T703285

Tappo rosso (32)
350



T703110

Tappo rosso
+ guarnizione 5cp 2150



T703115-5CP

T703117-5CP

Pistone ceramica

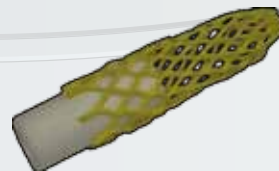

T703310

Biella per pompa CAT
340/350



T703080

Tappo di valvola 350/5CP



T703090

Oblò di controllo
livello olio 350/5CP/3CP



T703100



Pompa W98 DX
IGW00098

Pinza a labbro per pompa
CAT



T713010

Chiave a tubo per pompa
CAT



T713020

Kit4: 6 tappi + o-ring

Kit 1: 6 valvole

Kit 60 : riparazione interna
K5

Kit 123: 6 valvole



IGKIT4



IGKIT1



IGKIT60



IGKIT123

Kit 131 : Tenuta
alta/bassa press. per un
pistone

Motore 3Hp 2.2 Kw 380V
950g/min 6 poli
H112/B3/B14

Giunto elastico HP 2,5/3/4

Flangia HP 2,5/3/4



IGKIT131



GM705050 RA



IGZG091



IGZF91

Antivibrante diam. 40mm
H30mm vite M10

Valvola di
sicurezza K1

Valvola di
sicurezza K3.1

Valvola di
sicurezza SR

Valvola di
sicurezza K5.1

Testa pompa W130
W124 ø PIST 15



CMT P403010MA



IGZK1



IGZK31



IGZSR



IGZK51



IG44120041

ESPLOSO POMPA HAWK H306

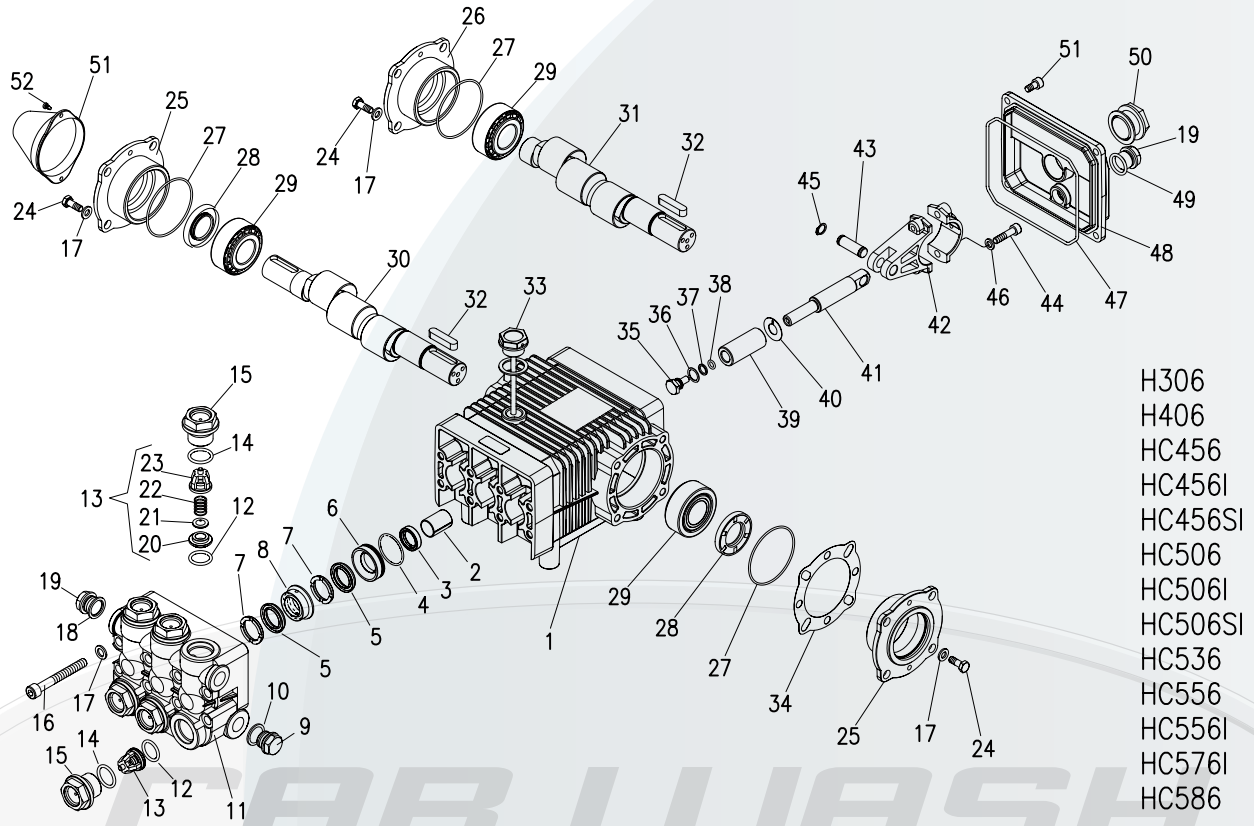

- H306
- H406
- HC456
- HC456I
- HC456SI
- HC506
- HC506I
- HC506SI
- HC536
- HC556
- HC556I
- HC576I
- HC586

Pompa Hawk H306 Bialbero

Giunto elastico (28-22) per pompa H300/H306/ mot. H110

Campana di accoppiamento per pompa H300/ H306/ mot. H110

Biella per pompa H300/H306



LEH306



LE241500 x



LE243101



LE010001

Valvola nuovo modello (bianca) H300/ H306



LE260008

Kit tenute per un pistone per pompa H300/H306



LE260800

Kit tenute per 3 pistoni per pompa H300/H306



LE260801

Kit corteco pistone (3PZ) H300/H306



LE260803

Compatibili con qualsiasi impianto

Pompe NMT

NOVITA'
Pompa HAWK NMT 1220 SR



SERIE NMT

Pompa HD 1415



SERIE HD

Affidereste la vostra pressione ad una pompa mediocre? Probabilmente no e Hawk lo sa bene, per questo produce e sviluppa pompe a pistoni ad alta pressione, componentistica e ricambi di indiscussa qualità. Hawk progetta minuziosamente ogni elemento per rendere l'acqua un'arma perfetta.

PRODUZIONE ITALIANA

LE NMT 1220

Pressostato 3 fili
40 bar 1/4" M



MTM15140

Manometro Inox
glicerina 0-160 bar
radiale ATT 1/4" d. 63 N



MTMOIX91160-63

MTMOIX92160-63

Manometro Inox
Glicerina 0-250 bar
assiale alt.
1/4" D. 63M



MTMOIX92250-63

Manometro Inox
Glicerina 0-160 bar
assiale alt.
1/4" D. 63M



RADIALE

ASSIALE

Vaso d'espansione anti-ariete F3/8" (0,35Lt)



MTM20005

Regolatore di
pressione
con manopola



MTM35207

Regolatore di
pressione
senza manopola



MTM35208

Regolatore di pressione
VRP 200 30 Lt 250
bar senza manopola



PA60.0220.60

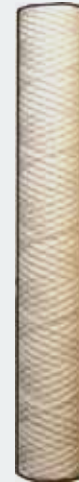

RACCORDERIA VARIA

Filtro 50 mic 50 cm 20"
autoequipeFiltro 60mic. 50cm
20" Rete NylonFiltro 20/25mic.
50cm 20"Filtro mix carbone
25 mic 25 cm
9" 3/4Filtro 5mic.
25cm 9" 3/4Filtro
25cm 9"3/4
trasparente con
carboneFiltro Carbon Block
5 mic. 9"3/4

AT201070

AT201021L

WL201010

AT201130L

WL201080

WL201020L

WLCX100024

Filtro Carbon
Block 20" 5 micFiltro BIG Carbon
Block 20" 5 micFiltro cartuccia
fiocco di propilene
20" 5 micronPortafiltro 3Pz 20"
att. 1" inserto
in ottonePortafiltro 3Pz 9"3/4 att. 1"
inserto in ottoneChiave per
portafiltro

WLCX100224

WLCX100424

WLFIO20-5

WL201320-1

WL201310

WLCHIAVE

Filtro a Y inox
3/8" 500 micFiltro a Y ottone
3/8"400 micGalleggiante a doppio
contatto (rosso)Rubinetto galleggiante
per vasca acqua calda
1/2"Galleggiante 2 livelli
inox

MTM89X010

MTM89010

SG203070

PA29016010

ESIMP260-001/0



Membrane
per osmosi 4040; 4021; 2540; 2521

Disponibili RESINE e SALE
Sacchi 25 Kg

Valvola Fleck
automatica

WLFL

Bombola addolcitore
13x54 100lt (66lt resina) ENPRESS

WLBEN1354BL



Tino sale 100Lt
d. 47xh. 63 completo

WLSE00106

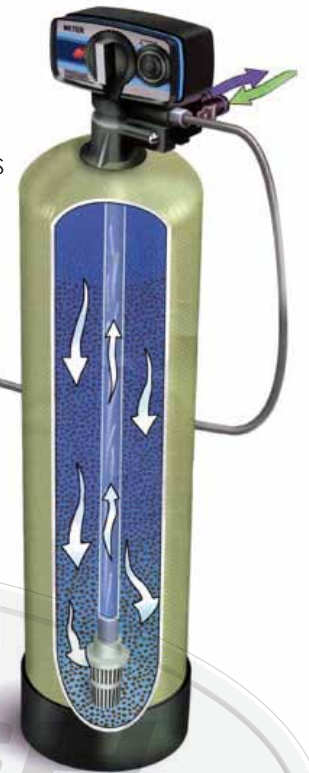

Pompa rotativa
400 lt/h att fascetta
+ by pass

Pompa rotativa
1000lt/h att
fascetta + by pass

Motore elettrico
1 HP/220V-50Hz 750W



WLPO201813



WLPO201819



WL209035

Kit giunto + campana
per motore 1/2 hp
B14-M71



WLKITGIUNTO71

Kit giunto + campana
per motore 3/4-1 hp
B14-M80



WLKITGIUNTO80

Misuratore di PH
mod. Chant



WLHI98106

Misuratore di
conduttività
DIST 3 0-1999 MS



WLHI98303

Misuratore di
conduttività 'EC/TDS
professionale



WLHI99300

Acquatest 2 Flaconi
(2 reagenti) durezza



WLKA001015

Soluzione taratura
1413ms
(min 5PZ/conf 25pz)



WLHI70031P

Manometro plastica a
secco 0-10 bar
radiale 1/4" D. 50 MM



VU212010

Manometro plastica
a secco 0-10 bar
assiale AT 1/4"
d. 50mm



VU212020

Manometro inox
glicerina 0-25 bar
radiale
AT 1/4" d. 63mm



VU D215/6

Flussometri



SG16040

Valvola a spillo FF3/8" inox
AISI 316



WLOI201905

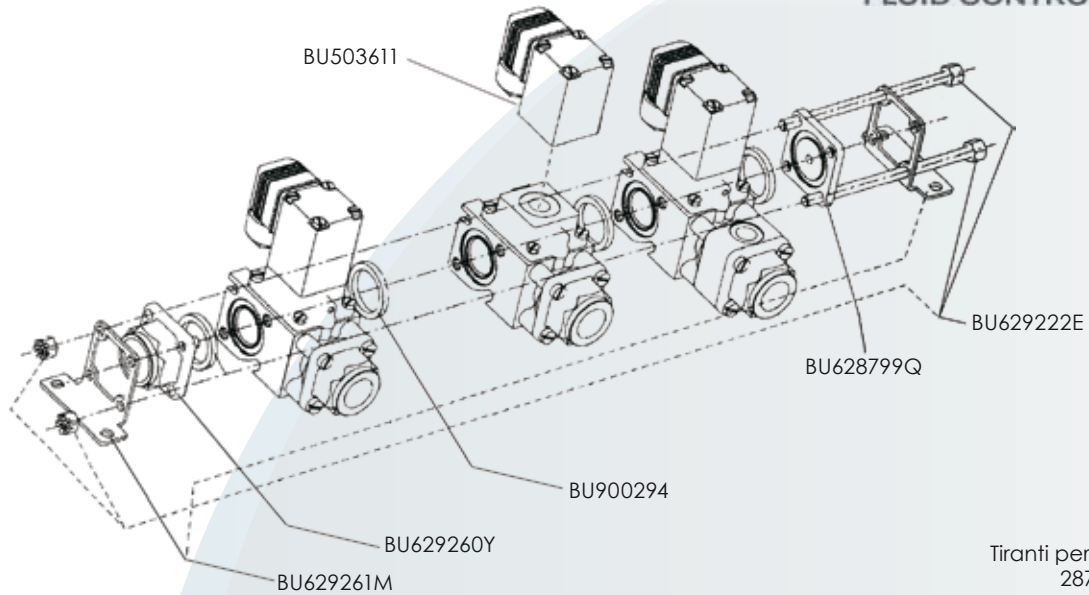

Tiranti per rampa 287

ESPLOSO 287

Coppia sostegni per rampa 287

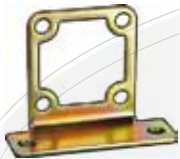

BU629261M

Piastra di connessione 1/2" per rampa 287 c/o-ring



BU629260Y

Guarnizione O-ring per rampa 287



BU900294

Piastra di chiusura rampa 287



BU628799Q

Bobina 24V ca per 287 N.C.



BU503611



Varie misure

Rampa 287



RAMPA 287

Ev 287 distributrice G 1/2" PPE+NBR 24V ca



BU17317

EV 287 miscelatrice G 1/2" PVC + NBR 24V ca



BU017463N



BU624014

EV 6013 G 1/4" foro 3mm Inox 24V ca



BU82431

EV 6013 G 1/4" foro 3mm OT+FPM 24V ca



BU125302W

Kit riparazione 6013



BU431704U

Ev. pneumatica 2000 inox, sede inclinata a Y



BU130407

EV 290 G 1/2" foro 12mm OT+NBR 24V ca



BU043816J

EV 6213 G 1/2" foro 10mm
OT+NBR 24V ca



BU126261V

EV 6213 G 1/4" foro 10mm
OT+NBR 24V ca



BU139101T

EV 6213 G 3/4" OT+NBR
24V ca



BU126273Z

EV 6213 G 1" foro 25mm
OT+NBR 220V



BU134680W

Corpo elettrovalvola 6213
3/8"



BU125692M

Bobina 24V ca per corpo
EV 6213



BU125724L

Ev 3 vie 1/4" Asco
SCE37374A002



CHI11500634

Ev 3/8" 0,7-100
bar 24V aisi
8mm ASCO



CHISCXB223A127

Kit di riparazione
Ev ASCO 1/2"
CHI11590191



CHI131600

Corpo
elettrovalvola
ODE 3 vie 1/4"



ODE1

Corpo
elettrovalvola
ODE 2 vie 1/4"



ODE2

Corpo
elettrovalvola
ODE 2 vie 1/2"



ODE4

Elettrovalvola
ODE 1/4" N.A.
220V ottone



ODE5

Bobina 48V
per
elettrovalvola
ODE
1/4"-3/8"-1/2"



ODE BOB 48

Membrana buna
per ODE 3
e ODE 4



ODE MEMB

Nucleo +
molla
per ODE 2



ODE NU

Misuriamo il passo:



10 mm



13 mm



17 mm



21 mm

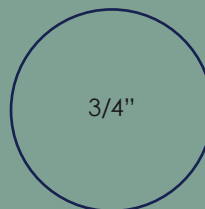

27 mm

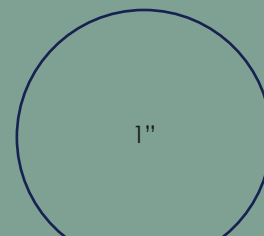

34 mm

Collettore 1/2" inox 4 o 6
uscite 2 ingressi + staffe



MOCO1/24S 4uscite

MOCO1/26S 6uscite

Valvola bp
anti-ritorno inox FF



MONDEO1/4 1/4"

MONDEO3/8 3/8"

MONDEO1/2 1/2"

Valvola bassa pressione
anti-ritorno OT FF Europa



MTM37100 3/8"

MTM37101 1/2"

Valvola HP anti-ritorno inox
FF



PA60203000 1/4"

PA60202000 3/8"

PA60207000 1/2"

Rubinetto minisfera inox MF
leva blu piccola



MORUBMF1/4 1/4"

MORUBMF1/2 1/2"

Elettore antigelo in ottone
MF 3/8" c/portatubo



MTM29036

Rubinetto sfera ottone FF
1/4" leva rossa lunga



MTM89701

Rubinetto minisfera ottone
MF1/4" leva nera piccola



VU A311/3

Dosatron D07 RE 5 portata
5-700 l/h reg 0,8%-5, 5%
compact



DD07RE5

Dosatron DI 25 portata
2,5 mq/h reg. 3% - 10%



DDI25RE3-10

Ins. parte di dosaggio V AF
DII 50 diam. 20mm



DDCDDI052VAF

Pompa Ulka EP7
50 HZ NBR
24 V



ULKAEP7-24v

Pompa Ulka EP7
50 HZ NBR
220 V



ULKAEP7-220v

Membrana per pompa
Lang pneumatica L=14mm



L401 MP1

Valvola di spurgo per
pompa dosatrice Lang



L402152

Valvola anti-ritorno Lang



L402153

Pompa dosatrice manuale
5l/h 5 bar 220V dutral n.m.



ETPKX0103905

Pompa dosatrice manuale
5l/h 7 bar



ET401020NM

Pompa dosatrice asservita
10l/h 10 bar 4 funzioni



ETDLSVFT1010

Pescante viton



ET402076

Testa per pompa standard
(da 2 a 15lt) viton



ET TESTA 1

Testa per pompa
oltre 20 Lt



ET TESTA

Membrana per pompe
standard (da 2 a 15 Lt)



ETMEMBRANA1

Membrana per pompa
oltre 20Lt



ET MEMBRANA

Valvole + O-ring NITRILE



ET

Valvola iniezione
Dutral/Viton



ETVALVIND

ETVALVINV

Pescanti vari



CODICI VARI

Membrana Seko 602/603



SEKO MEMB 602

Pompa diretta 603AKS 220V
8L-1b/6L-5b/5L-8b



SEKO603AKS

Testa Seko 602/603



SEKOTESTA602/603

Contalibri 35 imp/L acqua
calda 1/2"



GI407080-2

Contalibri 4 imp/L acqua
calda 1/2"



GI407080

Pompa Emec F/FCOW 5 bar
5 lt verde



EMFCOW5bar5lt

Valvola iniezione 1/2" 6x4
WAX verde (per cera)



EM07305371

Valvola iniezione 1/2" 6x4
Dutral bianca(shampoo)



EM07302541

Testa completa per
pompa mod. FCOW



EM02004821

Kit 2 valvole wax
verdi per cera



EM11002191

Kit 2 valvole dutral bianche
per shampo



EM11002031

Pompa pneumatica 3L/6bar, 6L/6bar,
12L/6bar S/EV



EMRAC

Pompa pneumatica 3L/6bar, 6L/6bar,
12L/6bar C/EV



EMRACV

POMPA DOSATRICE DIGITALE MULTIFUNZIONE



Caratteristiche Tecniche:

- 6 l/h - 7 bar
- dosaggio da 0,01% a 99,9%
- Assemblato su pannello rigido pronta al fissaggio e circuito completo di Contalitri 1/2" e raccorderia.



Pronta all'uso



Braccio rigido L 1750 uscita 3/8"

MTM180030

MTM180130



Braccio semirigido L 1750 uscita 3/8"



Braccio rigido doppio L 1600 / 1750 uscita 3/8

MTM184020

MTM184120

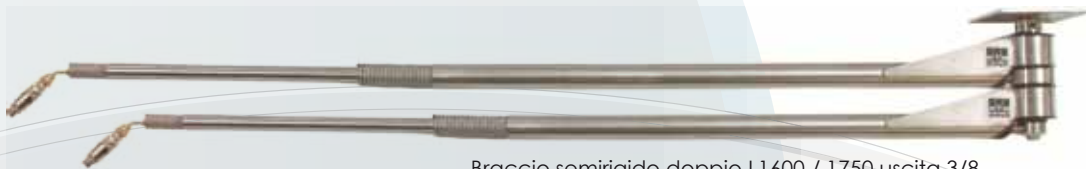

Braccio semirigido doppio L 1600 / 1750 uscita 3/8



Braccio a 'Z' semirigido L 1550 uscita 3/8"

MTM186120



Braccio semirigido L 1750

PA28.3000.00

PA28.3100.00



Braccio semirigido doppio L 1600/1750

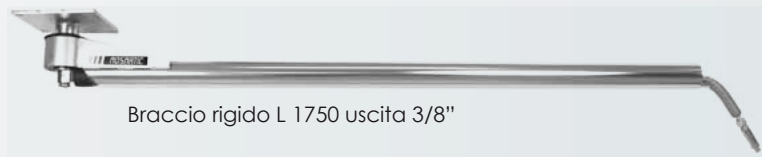

Braccio rigido L 1750 uscita 3/8"

MOS66.023

MOS67.413



Braccio rigido doppio L 1600/1750 uscita 3/8"

MTM250035



Prolunga per bracci MTM

Raccordo girevole dritto



MF 3/8

MTM18K503

M 3/8 F 1/4

MTM18K502

MF 1/4

MTM18K501

Raccordo girevole 90°



MF 3/8

MTM18K523

MF 1/4

MTM18K521

M 1/4 F 3/8

MTM18K524

Raccordo girevole 90°



F 3/8 F 1/4

MTM75030

F 3/8 M 1/4

MTM75032

F 3/8 M 3/8

MTM75036

Raccordo girevole inossidabile 90° per lavaruote portali di lavaggio



Attacco 1/4 BSP MF

MTM26.0100

Kit girevole intermedio braccio doppio



MTMOT18A0753N

Raccordo girevole 90° 3/8" per bracci SONAL



MTM18K527

Kit riparazione MTM giunto girevole dritto



MTM18K001

Racc. girevole PA SW5 1/2" MF inox



PA26107000

CAR WASH SHOP & SERVICE

Racc. girevole dritto PA SW25 inox MF



MF 1/4

PA26120020

M 3/8

PA26120040

Racc. girevole PA SW90 INOX MF



MF 1/4

PA26130020

MF 3/8

PA26130040

Racc. girevole 90° Mosmatic Inox



MF 1/4

SG811110

MF 3/8

SG811120

Racc. girevole dritto DGV Mosmatic inox



MF 3/8

SG811050X

MF 1/4

SG811020X

Kit per raccordi gir 90° SW90



PA 26130524

Kit O-ring/Bk giunto intermedio braccio doppio



MTM18K002

Racc. gir. dritto per pistola MF3/8"



MTM75012

Innesti rapidi a sfere inox 3/8" F



MTM72001

MTM72002

Pistola Aura grill. blu 25L 3/8" F gir. perd. 0,6 L/min

Pistola Aura grill. verde 25L 3/8" F girevole

Pistola Aura senza grilletto 25L 3/8" F

Pistola RL26 grill. blu 3/8" M

Pistola Astra grill. nero 40L 3/8" F non perdente



MTM26371A

MTM26871

MTM27301

PA30179200

MTM23001

TUBI ALTA PRESSIONE

LEGERISSIMI

INTERNO: treccia singola in teflon
ESTERNO: Guaina in materiale termoplastico antimacchia doppia manopola in PVC Raccordato 3/8 FF

Tubo 1/4" termoplastico 3,50/4,20/5,00 mt 300 bar aff. 3/8" Treccia Metallica singola



L 3,50 mt
RM 3,50 argento

L 4,20 mt
RM 4,20 argento

L 5,00 mt
RM 5,00 argento



L 3,50 mt
RM 3,50 rosso

L 4,20 mt
RM 4,20 rosso

L 5,00 mt
RM 5,00 rosso



L 3,50 mt
RM 3,50 blu

L 4,20 mt
RM 4,20 blu

L 5,00 mt
RM 5,00 blu

Tubo spirale blu



ADSPIRALEBLU 10/7,5/5 SENZA MEMORIA

Tubo spirale giallo



ADSPIRALE10/7,5/5 SENZA MEMORIA

SPSPIRALE10/17 CON MEMORIA



TK 95-001/2/3

Raccordo girevole per spirale M/F 1/4" (8 x 5)



ADRACSPI1/4M/F

Ugello nebulizzatore 1/4" plastica



ADUGELLO

Ugello neb TP inox



SP802995

Pistola per nebulizzatore leva verde perdente



CHPISTOLA1

Pistola per nebulizzatore leva grigia



CHPISTOLA

Ugelli neb TP in plastica 110° :



Diam. 0,9 CH2015001

Diam. 1,1 CH2015002

Diam. 1,3 CH2015003

Diam. 1,4 CH2015004

Diam. 1,8 CH2015006

Lance e spazzole

Lancia Spada L750 Inox manico rigido nero



MOS801090

Lancia Spada L750 Inox manico morbido nero

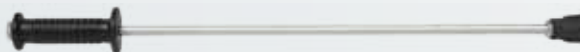

MOS28415

Lancia spada blu/nera filtro fisso L700 Inox 1/8



MTM1930110/B

Lancia Inox s/ugello c/portaugello

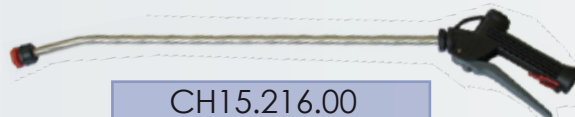

CH15.216.00

Lancia PVC s/ugello c/portaugello

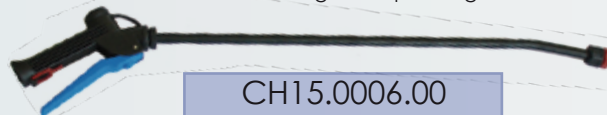

CH15.0006.00

Lancia nuda MT3 L700-900-1200 Inox/Fe zn inclinata

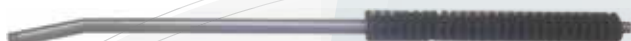

MTMTBPLIX070/090/120

MTMTBPLFE070/120

Lancia Elite Inox punta inclinata L700-950-1200



MTM62513-I 700

MTM62523-I 950

MTM62533-I 1200

Lancia Elite Inox punta dritta L700-950-1200



MTM62513 700

MTM62523 950

MTM62533 1200

Lancia completa MT3 L500 Inox dritta ricoperta



MTMMT3500

Lancia R5 Inox atermica inclinata L700-900



PA40570500

PA40590500

Guaina per tubo lancia al mt.



MTMG0244342

Pistola lancia e adattatore Inox per lavacerchi



AQ PF1

Lancia doppio prodotto



CH15.0008.51

Spazzola setola naturale con supporto cm 6 oppure cm 9



MTM20154 6 cm
MTM20155 9 cm

Spazzola setola naturale senza supporto cm 6 oppure cm 9



MTM201K011 6 cm
MTM201K012 9 cm

Spazzola setola sintetica cm 8 morbida



MASPAZZOLA

Spazzola economica 1/4 F Setola 6 cm in propilene



CWS SPAZZOLA

Supporto in plastica per spazzola



MTM201K010

Supporto Inox con fori per spazzola



SG815060

Portaugello 1/4-1/4 con protezione nera



MTM193K501

Portaugello 1/4-1/4 con protezione blu



MTM193K501B

Protezione ugello (più dado)



PA4000485/384

Supporto alluminio con fori per spazzola



SP815050

Maschera in plastica per spazzola



SP815020



PER INDIVIDUARE LE CARATTERISTICHE DELL'UGELLO CONTROLLARE LE SIGLE E I NUMERI STAMPATI SU DI ESSO
Esempio: 6503 - 65 = 65° angolo d'uscita dell'acqua
- 03 = 6,81 L/min a 100 bar di pressione (controllate nella tabella sottostante)

Portaugello 1/4 FF con protezione nero/rosso



RMPROTROSSO

Portaugello 1/4 FF con protezione nero/blu



RMPROTBLU

Portaugello 1/4 FF con protezione nero/grigio



RMPROTGRIGIO

CODICE	PRESSIONE		
	100 bar	120 bar	150 bar
03	6,81 L/min	7,40 L/min	8,40 L/min
04	9,10 L/min	10,00 L/min	11,20 L/min
05	11,40 L/min	12,50 L/min	14,00 L/min

Vi ricordiamo inoltre che un ugello troppo usurato comporta un sovraconsumo di acqua notevole. E' quindi consigliabile la sostituzione dell'ugello ogni 200 ore.

Pistola SG35 gril. nero 45L 350 bar 3/8 F



MTM10.0341

Att. rapido FM22x1,5-F3/8 Nipplo adat. M22x1,5-M3/8



MTM70108/007

Manico nero/blu per lancia a spada



MTMPL193L0587N/B

Iniettore per schiuma



MTM29301

Supporto lancia flessibile a
pavimento inox

MTM130500

Supporto lancia flessibile a
parete inox

MTM130510

Supporto lancia rigido a
parete inox

MTM130540

Supporto lancia rigido a
pavimento inox

MTM130520

Supporto lancia in plastica
blu/grigio

PA28323000

blu

PA28323030

grigio

Portancia/spazzola inox
dritto900mm
150mm
300mm

CMTCW06PSI

Portancia/spazzola inox
obliquo

CMTCW14PSO

Portancia/spazzola in
plastica blu/grigio

PA28327000

blu

PA28327030

grigio

Lancia retrattile perpendi-
colare Karcher

SG801140

Supporto per lancia
perpendicolare Karcher

SG806120

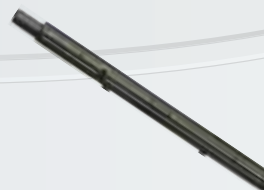
Impugnatura a forma di
mezzaluna Karcher

SG806110

Impugnatura Mobile per
lancia perpendicolare
Karcher

SG806200

Snodo Quick Jet per
spazzola

MTM20130

Pulsante giallo per spazzola
KarcherCalamita per linguetta
Karcher

SG806090/6100

Linguetta in gomma
rompigetto Karcher

SG806130

Protezione gialla ugelli
Karcher

SG806140

Gettoniera elettronica RM5 tropicalizzata/HD



CORM5

Programmatore per gettoniere tipo RM5



CORMPRCHRM5

Supporto frontale per RM5 piccolo/standard/grande



CO/RM-F1

piccolo

CO/RM-F6

std

CO/RM-F3

grande

Gettoniera B 400 elettromeccanica 24Vca



COB400F61ETK

Gettoniera a comparazione G20 12 v.



RU G

Gettoniera elet. AL06S scarto frontale



ALGETTO206S

Protezione in plexiglass



SP930000

Protezione in plexiglass con calamita Mosmatic



SP1404460

Lettoce di banconote EBA03 standard



CHA EBA03

Protezione gettoniere a ghigliottina Inox + Plexiglas



CMT CW19

Setaccio dividi monete 4 pezzi



CO FACILE4

Copertura (involucro) alluminio verniciato 600/800



CMT CW13800IAL

Pannello frontale adesivo T.MIX



CMT CW08 B MIX

Scheda gestione MON 5 per alta pressione



CO MON5HP

Alimentatore RM925 24 Vca/24 Vcc/220Vca/12Vca



CO ALIMENT

Scheda programmi MIX



MIX CHEDA

DISPONIBILI REVISIONATI

CAR WASH SHOP & SERVICE

Pulsanti e spie per lampada/led Telem. NM
blu/verde/rosso/giallo/bianco



SG1005055/25/35/45/15 FEIZB4BV43/53/33/63

Pulsante STOP d'emergenza
Telem. NM



Supporto nudo per
pul/spia/stop Telem.
NM



SG1005205

SG1005115

FEIZBV

Sistema di attivazione
multiservice 6 o 2 prog



CO-E-E6P/E2P

Hopper per cambiamonete



CO/HOPPER

Sistema cashless



CO/EUROKEY

Letto di banconote NV10



CO/NV10

Distributore gettoni
Autocoin ADVANCE



CO/AUTOCOINAD

Distributore gettoni
Simplystart ADVANCE



CO/SIMPLYAD

Quadro comandi Pit Start



CO/PITSTART

Letto di banconote con
impilatore NV9



CO/NV9

Protezione silicone
trasparente NM/VM



FEIZBPOPROSIL

Pulsante a sfioro mod. MIX



KS1241300

Micro interruttore a filo



RUMICRO

Serratura c/2 chiavi L23



CO/SCT23KA

Macchine COMESTERO GROUP
in funzione presso il nostro
magazzino di Rivoli (TO)

CO/SIMPLYAD

CO/AUTOCOINAD

CO/PITSTART

CORNER COMESTERO GROUP

*Carwash è il centro d'assistenza raccomandato per
Valle D'aosta, Piemonte e Liguria*

*Comestero Group è leader, da oltre 30 anni, nei sistemi di
pagamento e controllo denaro.*

QUALITA' DEI DETTAGLI

Serrature di sicurezza con chiusure a sei punti.



Retroilluminazione a Led



Pedale per spremipelle AD



ADPEDALE

Maniglia per spremipelle AD



ADMANIGLIA

Coppia di rulli per spremipelle AD



ADRULLI

Bronzina per spremipelle AD



ADBRONZINA

Turbina per aspiratore 2,2 Kw



ADTF005

Base per bidone/fusto aspiratore d400 x h535
Coperchio per bidone/fusto d400 con galleggiante



S00874BASE/SR6659

Filtro per aspiratore AD autopulente



ADMCA005

Filtro completo conico alto d400



S3240

Filtro completo conico basso d400



S6136

TUBO ASPIRAZIONE



Ø38

GRIGIO-NERO

SP1107101

VERDE-BLU

RMTUBOV/BLU38

AZZURRO

RMTUBOAZZ38

BLU

SG1107020

NERO

GH1107100

TUBO ASPIRAZIONE AL MT



Ø38

GH1107100

Ø36

S624

Ø51

S1107110

Nero Ø51 al metro
Nero Ø38 al metro
Nero Ø32 al metro

Bocchetta PVC anti-rottura
d38 colorata

Rossa SP1108092

Blu SP1108093

Nera SP1108094

Vista in sezione



Bocchetta GOMMA per tubo d38



TRL1108090 GO

Bocchetta PVC Gialla per tubo d38



TRL1108091

BOCCHETTE IN GOMMA
Minor possibilità di rottura
Evita danneggiamenti sulle
plastiche dell'auto

RM 2640191

Bocchetta in gomma deluxe tubo Ø38



Raccordo gir. tubo/bocchetta d38/d51	Raccordo fisso tubo/bocchetta d38/d51	Raccordo gir. tubo d38 bocchetta d51/tubo 38 bidone	Raccordo tubo d38 bidone	Raccordo girevole in gomma d38	Bocchetta lavainterni completa	Rubinetto bocchetta lavainterni	Bocchetta lavainterni nuda
S1108015/20	S1108040/70	AD1108010	S1104070	SP1108080	S00752/OTT	S07553	S00651

Bocchetta per lavainterni AD produzione	Tubo per lavainterni completo	Motore aspiratore 1000/1200 W/LAMB Carboncino per motore	Scheda con display per aspiratore AD
ADMANIC	S0TLAICOMP	SG1106015/25/10	ADE0089

Pennello rotondo d38	Connettore d38 per bidone/fusto	Bocchetta e raccordo gir. per asciugamato AD	Bocchetta PVC per tubo d32 Raccordo gir. tubo/bocchetta d32 (per asciugamato)
S06295	S02653NE	ADMC0163/ADID0106	S617/32 S622

Spazzole per lavapetiti AD, DAERG e KASTER	Pedale strizzapelle Kaster	Filtro per aspiratore Kaster	Tubo lavainterni Kaster
SPAZZOLE	MTM 20.0102	MTM KASAC001	MTM 25.89

Palo porta braccio sezione tonda

Sbattitappeto zincato con protezione zincata o colorata

Portacasco

Pinza per tappetini

Pistola per aria compressa



CMTCW03F/VGIA/VBL/VRO/VVE

CMTCW09PC

SPPINZATAP

ADID0080

Sbattitappeto con cassetto Fe Zn/inox

Sbattitappeto zincato attacco a pavimento

Porta sacco rifiuti a parete verde/giallo/rosso

Cestino 120 Lt per rifiuti



110mm
50mm
50mm



110mm
56mm



CMTCW18

CMTCW15F/X

CMTCW03A

CMTCW17PARVE/GI/RO

DSBIDONE

Presscontrol Grundfoss 2.2

Avvolgitubo

Elettropompe motori elettrici e inverter a richiesta presso il nostro ufficio commerciale



GMPRESS2



MTM20025

Nebulizzatore "Spray Kim" ferro verniciato 50 L/24 L/10 L

Nebulizzatore "Spray Kim" 24 L inox



MTMN00FR0050G



MTMN00IX0024G

PRIMA



Minima spesa, massima resa.

Possibilità di cambiare totalmente il look del vostro impianto senza sostituire le macchine ma rivestendole con adesivi di ottima qualità dotati di grafiche moderne capaci di dare nuovo splendore al vostro autolavaggio.

Preventivi ad hoc per ogni esigenza.

DOPO



IMPIANTO NUOVO? oppure NUOVA GRAFICA

PER ORDINE DELLE AUTORITA'

VIETATO

USARE PRODOTTI CHIMICI PERSONALI!
L'utilizzo dello spugna nei motorini di iniezione, affluenza

ATTENZIONE - IMPORTANTE E' VIETATO

L'UTILIZZO DELLA SPAZZOLA PER SHAMPOO, SE PRIMA NON VIENE ATTIVATO IL PROGRAMMA SPECIFICO. L'INOSSERVAENZA PUO' CAUSARE GRAVI DANNI ALLA CARROZZERIA CAUSATI DALLA FORMAZIONE DI RESIDUI ALL'INTERNO DEL CONTENITORE DELLA SPAZZOLA. LA DIREZIONE DECLINA OGNI RESPONSABILITA'

ATTENZIONE - IMPORTANTE E' VIETATO

LAVAGGIO MOTORE E TELAIO

PANNELLI PERSONALIZZATI

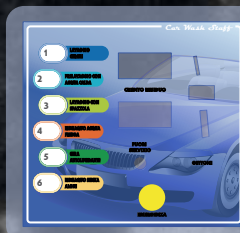

1 GETTONE
2 GETTONI
5 GETTONI
11 GETTONI

SPAZZOLA

PORTACASCO

VIETATO USARE LA SPUGNA

VIETATO LAVARE IL MOTORE

ADESIVI IN PVC ANTI UV

I NOSTRI SERVIZI

- CARTELLONISTICA PERSONALIZZATA
- INSEGNE LUMINOSE
- ADESIVI PVC CON PROTEZIONE UV
- BANNER PUBBLICITARI
- GRAFICA PUBBLICITARIA
- PERSONALIZZAZIONE ABBIGLIAMENTO TECNICO

"Potete trovare soluzioni ai problemi complessi semplicemente dividendo il problema in problemi più piccoli" (Philip B. Crosby)

GETTONI PERSONALIZZATI

Migliaia di combinazioni

Quantitativi d'ordine minimi,
Grafica e preventivo gratuiti

ZAMA



Diametro da 23 a 26 mm
Spessore da 2,2 a 3,0 mm
Combinazione cave: 2+1 2+2 3+0 3+3

BIMETALLICI
Monocolore



Diametro da 22 a 28 mm
Spessore 2,0 mm
Materiali: OT58; OT63; OT67

MONOMETALLICO

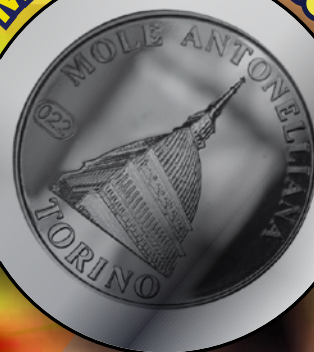

Diametro da 23 a 26 mm
Spessore da 2,2 a 3,0 mm
Materiali: OT58; OT63; OT67

BIMETALLICI
Bicolore



Diametro da 22 a 28 mm
Spessore 2,0 mm
Materiali: OT58; OT63; OT67

FERRO NICHELATO



Diametro da 22 a 28 mm
Spessore 2,0 mm
Combinazione cave: 3+2,3+0,2+2,2+1,2+0

La giusta immagine, per il vostro "tesoro" in gettoni.

ROTOLI CARTA

Adatta alla pulizia dei vetri
Direttamente dalla cartiera



Carta bianca a secco un velo

IC BOB AS

Carta blu doppio velo

IC BOB BLU

Carta bianca doppio velo

IC BOB PC

Bobina Sontara per Pannomat

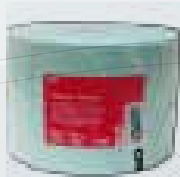

CAK00011

Le resistenze adesive consentono di proteggere i punti critici soggetti a congelamento come elettronica, tubazioni e taniche prodotti

Resistenze Anti-gelo per impianti



RESISTENZE ADESIVE -27x20 cm 15x8

CARRELLI
SHOP & SERVICE

Macchine Carrellate

Idropulitrice professionale ad acqua calda Total Stop



ASPIRATORI



LAVAMOQUETTES



150 bar 15L/m
150 bar 21L/m
200 bar 15L/m

IDROPULTRICI

Resina Cationica al litro



Sacco 25l

WLMF300060



SALE IN PASTIGLIONI PER ADDOLCIMENTO in sacchi da 25 Kg.



WLMF300120

Guanto lavaggio
bianco



CWS GL

Spatola Detergente
con lama in Silicene



CWS SPATOLA



DISPONIBILI TAGLIE S-M-L-XL-XXL
Possibilità di personalizzazione con
il logo del vostro autolavaggio.

ABBIGLIAMENTO ANTINFORTUNISTICO

LINEA DI ABBIGLIAMENTO PERSONALIZZATO
Car Wash Staff



Kit Smoking
Cartine, Filtrini
e Accendino



CW 0002

Barattolo
Fresh & Clean



CW 0004

Lucchetto YALE ottone
cromato



CWS LUC Y120

Lucchetto YALE
corazzato 161

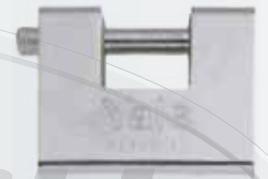

CWS LUC 161

PRODOTTI PER DISTRIBUTORE

Spugna sottovuoto



CWS SP SOT

Pelle sintetica in box



SPELLSINT

Deodorante in legno
mod. sandalo/infradito
(conf 24pz gusti misti)



CWS DEODSAND

Esosan gel
(gel antisettico) 100ml



CWS ESOSAN

RESISTONO A TUTTO...
...QUASI A TUTTO



Nuovi sacchi per immondizia
ultraresistenti con spessore
maggiorato per uso industriale
Mod: LOPE
Misura: 74x110
Capacità: 110 Lt.
Soffietti: 8 cm

Confezioni da 200 pezzi.

Le vendite effettuate dalla CAR WASH Shop & Service S.r.l. sono soggette alle seguenti Condizioni Generali di Vendita, ove non espressamente derogate per iscritto.

- ORDINI

Gli ordini pervenuti direttamente o tramite collaboratori alle vendite sono validi solo se accettati con conferma scritta, senza impegno sulla data di consegna e sui quantitativi. Abbiamo la facoltà di sospendere le spedizioni o di annullare gli ordini accettati in tutti i casi di forza maggiore che ritardino o non consentano, in tutto o in parte, l'approvvigionamento, o rendano onerose le forniture. In tal caso l'acquirente non avrà diritto ad alcun risarcimento.

- MODIFICHE SUI PRODOTTI

Tra la data di conferma dell'ordine e quella di esecuzione, ci riserviamo il diritto di apportare tutte le modifiche che riteniamo necessarie ed utili al funzionamento o al perfezionamento dei componenti e della apparecchiature da fornire, senza che ciò costituisca motivo per il compratore di recedere dall'acquisto o di pretendere risarcimenti od indennizzi di sorta.

- PREZZI

I prezzi della merce sono sempre quelli indicati da Car Wash S. & S. ed in vigore al momento della consegna, pertanto, i prezzi eventualmente indicati nell'ordine potrebbero avere un valore puramente indicativo. Tali prezzi non comprendono imposta sul valore aggiunto, spese di imballo e di trasporto.

- SPEDIZIONE

Qualora sull'ordine non sia precisato il modo di spedizione, ci riteniamo autorizzati a regolarci secondo nostro criterio e senza alcuna responsabilità.

- TERMINI DI CONSEGNA

I termini di consegna che, in ogni caso, decorrono dalla data della nostra conferma d'ordine, sono puramente informativi e quindi non essenziali né impegnativi. L'eventuale ritardo nella consegna delle merci confermate e l'eventuale esecuzione parziale della conferma d'ordine non daranno diritto al compratore di recedere dall'acquisto né di pretendere risarcimenti per danni diretti o indiretti, né di ritardare rispetto alle scadenze, il pagamento delle forniture già fatturate.

- CONTESTAZIONI E RESI

All'atto della consegna l'acquirente è tenuto ad esaminare attentamente la merce ed a contestare immediatamente per iscritto eventuali vizi. In ogni caso, trascorsi otto giorni dalla consegna della merce senza che Car Wash S. & S. abbia ricevuto contestazioni scritte da parte dell'acquirente, per quest'ultimo decade ogni diritto per vizi e/o mancanza di qualità della merce. Non potranno essere accettati resi se non autorizzati espressamente a noi attraverso l'apposito modulo..

- PAGAMENTI

I pagamenti dovranno essere effettuati alle condizioni riportate sulla fattura indipendentemente da qualsiasi contestazione o reclamo. Trascorso il termine di decadenza stabilito nelle condizioni di pagamento decorreranno gli interessi bancari oltre al rimborso delle eventuali maggiori spese. Qualora i termini di pagamento non fossero rispettati, la Società fornitrice ha diritto di sospendere ulteriori forniture in corso ed addebitare gli interessi di mora per ritardato pagamento al tasso commerciale corrente. Il pagamento del prezzo della merce non potrà essere differito per qualsivoglia motivo, anche in caso di contestazioni.

- GARANZIA

La garanzia copre per 12 mesi dalla data della fattura tutti i difetti dai materiali e di fabbricazione, e prevede la sostituzione di parti di ricambio o la riparazione dei pezzi difettosi esclusivamente a nostra cura e presso la nostra officina. Il materiale in riparazione dovrà essere inviato in Porto Franco. A riparazione avvenuta la macchina o il prodotto in genere sarà inviato in Porto Assegnato al cliente. La garanzia non prevede l'intervento di ns. incaricati sul posto di installazione, né l'eventuale smontaggio. Sono esclusi dalla garanzia:

- Guasti causati da utilizzo o montaggio non corretto
- Guasti causati da agenti esterni
- Guasti causati da incuria o scarsa manutenzione;

- LA GARANZIA DECADE

- In caso di morosità o altre adempimenti contrattuali;
- Qualora fossero fatte, senza il nostro consenso, riparazioni o modifiche alle nostre macchine o prodotti;
- Qualora il num. di matricola (ove esistente) venisse manomesso o cancellato;
- Qualora il danno venisse causato da un utilizzo scorretto, così come cattivo trattamento, colpi, cadute ed altre cause non attribuibili a normali condizioni di funzionamento;
- Qualora risultassero smontaggi o manomissioni non autorizzate;
- In caso i prodotti venissero impiegati per scopi diversi da quelli indicati;

- CATALOGO

Le caratteristiche degli articoli elencati nel nostro catalogo sono da intendersi come puramente indicative, resta perciò a carico del compratore il verificare la corrispondenza dei nostri prodotti alle condizioni d'uso da esso richieste. I colori dei campioni fotografati in catalogo, non sono necessariamente corrispondenti ai colori utilizzati nella produzione standard.

- RESPONSABILITA'

Siamo esonerati da ogni eventuale responsabilità ed obbligazione per qualsiasi danno subito da persone o cose in dipendenza dell'uso della merce fornita per cause o in dipendenza di essa, per vizi occulti, per difetto di costruzione o di responsabilità derivante da eventuali infrazioni da brevetti, marchi o modelli che venissero riscontrate sulle merci fornite.

- RISERVA DI PROPRIETA'

I beni oggetto della vendita rimangono di esclusiva proprietà della venditrice fino a totale pagamento del prezzo pattuito, come previsto dall' art.1253c.c.

Per ogni eventuale controversia e per ogni contestazione e competente in via esclusiva il Foro di Torino - Italia

Le suddette condizioni si intendono accettate integralmente ed incondizionatamente con l'emissione di ordinazioni scritte o verbali, salvo in presenza di esplicite deroghe scritte concordate all'atto della sottoscrizione dell'ordine ed accettate da CAR WASH Shop & Service S.r.l.

Ricerca e reperimento
componenti per ogni
marca e modello.

Spazzole
Motori
Pompe dosatrici
Elettrovalvole
Giunti



CAR WASH Shop & Service S.r.l.

Via Ferrero 108 - 10098 RIVOLI (TO) Italy Mail: info@carwashshop.it

Tel. (+39) 011/19700938 (+39) 011/19700939 Fax. (+39) 011/6696125

Numero Verde Gratuito

800 / 125790